

Corporate Training Dynamics and Insights

Pascal J. Gambardella, Ph.D.

Emerging Perspectives LLC
(Formerly, CSC, Catalyst Program)
12708 Chilton Circle, Silver Spring MD, 20904, USA
pascal@pascalgambardella.com
pascalgambardella.com

Charles Wainwright

(Formerly. CSC, Catalyst Program)
80 Rowley Bridge Road Topsfield, MA 01983

Helen E. Jones-Kelleher

(Formerly, CSC, Catalyst Program)
Royal Pavilion, Wellesley Road, Aldershot, Hampshire, GU11 1PZ, UK

Abstract

The Catalyst® Virtual Academy (CVA) is a training organization at Computer Sciences Corporation (“CSC”), a global, Fortune-500 Corporation of over 90000 people. It has been a great success over many years with participation steadily increasing. However, certain constraints on time threatened that success. What is causing these constraints on time and what could be done to improve this situation? This paper reports on a System Dynamics approach used to gain insight into this problem and discusses the process followed, the results, and the insights gathered on the journey to the results.

This paper may interest anyone who wants to have a clear understanding of the process followed in building and using a system dynamics model to gain insight into a real-world problem. In addition, it may be of interest to anyone managing an enterprise wide training organization.

1. Introduction

In January 2011, near the end of my work toward a master’s degree in System Dynamics at Worcester Polytechnic Institute (WPI), I needed a client with a problem that I could work on for

WPI's Real World System Dynamics course. Besides working through the client's problem for the course, I also wanted to address some questions of my own:

- How can the use of System Dynamics bring value within a large company?
- What is the value of the modeling effort?
- Is the journey to the results as important?
- Do the results leave a lasting impact?

Although I looked beyond my employer for clients, I found them at the company where I work. They run a corporate training organization, the CSC Catalyst Virtual Academy (CVA), which offers virtual training on the company's practice framework (known as "Catalyst") to over 90000 employees worldwide. This corporate methodology is critical to the success of the company since it provides practices and delivery processes that help the company provide value to itself and its customers. Although this entire paper is *jointly* written by the modeler and the CVA Leads, it is written primarily in the voice of the modeler and permeated with quotes from the CVA Leads to make it both easier to write and read.

The CVA delivers 2-3 hour courses several times during each week in different time slots to accommodate our global corporation. Each of these course deliveries is called a session. Sometimes a particular topic will cover two sessions. The CVA pieces together many different courses in a particular area (e.g., project management or architecture) as a curriculum.

We agreed to work on a model that provided insight into their problem, which we will discuss in the next section, rather than on a more calibrated model that could predict future behavior in detail. In deploying System Dynamics, creating an insight model takes the middle road. It goes beyond creating a purely qualitative model which just identifies major feedback loops and possibly system archetypes. It does not create a detailed quantitative model that strives to closely match the historical data so that it could be used to make short-term predictions. However, when creating our model we did match historical data as close as possible, not as much to make short-term predictions but to ensure the model results were in the right ball park. After we completed the initial simulation model we realized that the problem did seem to fit a system archetype, which will discuss later in this paper.

This paper has a dual purpose: to illustrate the process for those who have not had a chance to perform it themselves, and to promote the use of System Dynamics in a corporate environment. Since the CVA Leads and I are methodologists by profession, my approach included "speaking their language" by drawing process diagrams that illustrated the modeling process. These diagrams reflect a tailored version of the process taught in the WPI course, which did not use process diagrams. Since the CVA Leads manage a corporate training program, they were incidentally interested in creating System Dynamics awareness trainings and the process diagrams could support that effort.

We completed the first phase in April 2011, creating a model that provided insight into the client’s problem, and leading the analysis in some new directions. Our meetings were all held virtually: One client works in the United States near Boston, the other in the United Kingdom near London, and I near Washington DC.

The CVA is part of a larger corporate methodology group, which I (the modeler) joined in March 2012 and one of the CVA Leads now manages.

2. Initial Problem Statement

Here is the initial problem statement we created in January 2011 before we started modeling.

The Catalyst Virtual Academy (CVA) has been a great success over many years with participation steadily increasing. However, constraints on the CVA Leads’ time threatened that success. In addition, support staff who do administrative work were about to disappear. The CVA Leads became increasingly unable to spend all the time needed to develop and update course content, coach instructors, train participants, and advertise to targeted audiences. While this has not constrained growth to date, they feared this might happen in the near future. What is causing these constraints on time and what could they do to improve this situation?

There were rising company expectations to not only continue to provide high-quality training, but also to provide more of it to more employees. In addition, employees from companies acquired by our company were being required to take these trainings so they would better understand their new corporate culture.

This initial problem statement is vague, e.g., what constraints threatened success? What is interesting about System Dynamics is that it lends itself to novel approaches to further define the problem. Section 4 describes the first activity in this approach: Define the Problem. The next section summarizes the overall approach.

3. System Dynamics Approach

We used System Dynamics to gain insight into the problem and possible solutions. Figure 1 illustrates¹ our major activities:

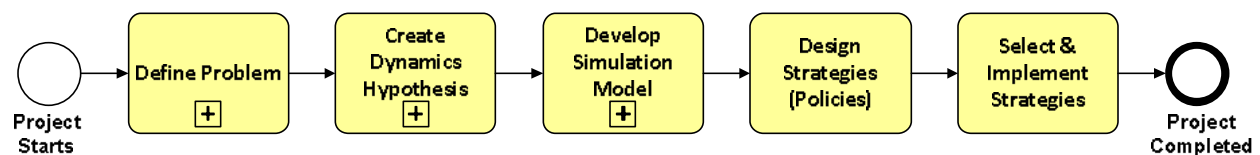

Figure 1. System Dynamics Process

- **Define the Problem** by examining the behavior over time of key variables and understanding current (momentum) solutions.
- **Create a “Dynamic Hypothesis”** by developing a qualitative model of internal feedback processes that could explain the observed behavior over time.
- **Develop a “Simulation Model”** starting with the dynamic hypothesis. The quantitative, simulation model was used to examine different scenarios and policy options.
- **Design Strategies (Policies)** that could provide solutions to the problem. Here the CVA Leads thought the word “strategies” was better than “policies” in explaining in their own language what was needed.
- **Select, Implement, and Communicate Promising Strategies (Policies)** resulting from the modeling process. Identify any system archetypes that might help communicate the situation.

Figure 2 illustrates the models and results associated with the process.

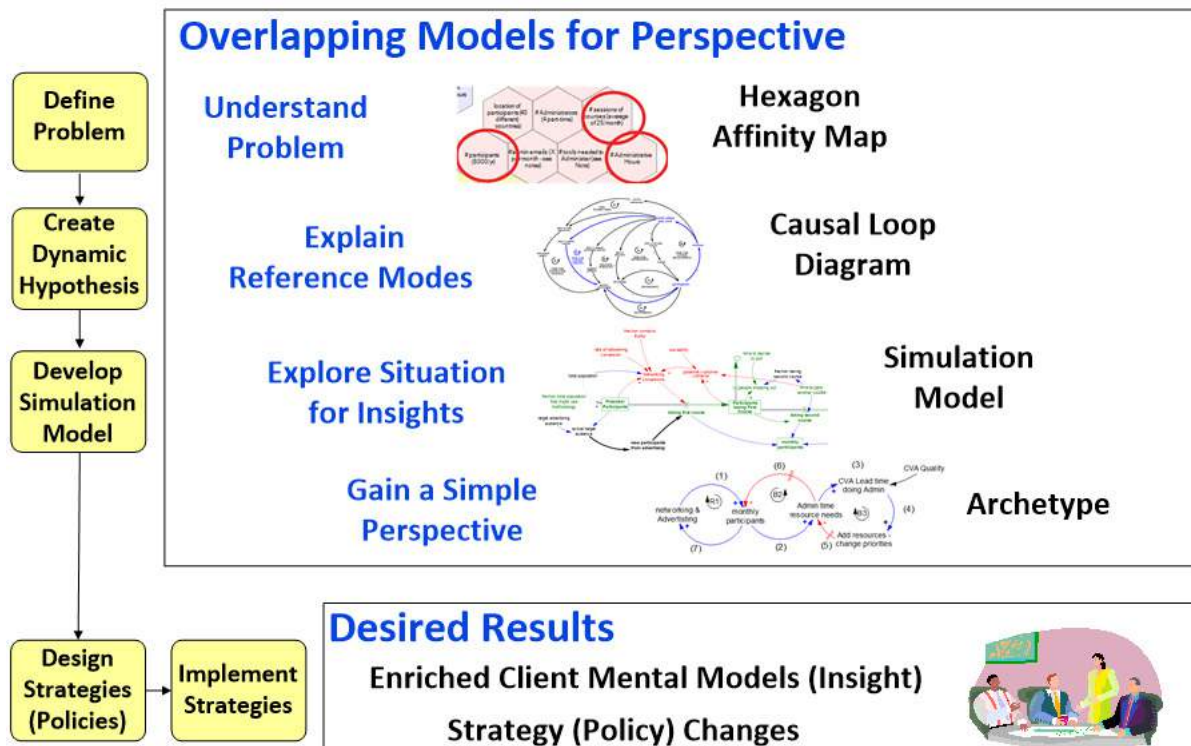

Figure 2. Models and Results

4. Define the Problem

Figure 3 summarizes the steps we used to define the problem, which was a new approach to the CVA Leads and led to some initial insights.

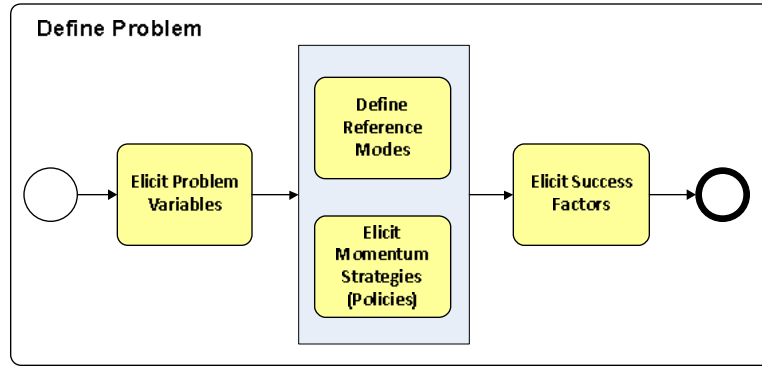

Figure 3. Define the Problem

4.1. Problem Variables

We listed the possible variables that might be involved in the problem and wrote the name of each within a hexagon. We grouped the hexagons so that related variables were next to or near each other. Finally, the CVA Leads selected the following three key variables that illustrated both the problem and the pain points:

- **Number of Participants** (per month), which is the total number of participants that attend a session each month. A person who attends more than one session is counted for each session attended.
- **Number of Training Sessions** (per month), which is the total number of 2-3 hour sessions given each month. There is a limit on the number of participants allowed in a session.
- **Number of Administrative hours** (per month), which is the time needed to setup and run each session per month, and some additional time each month to deal with issues (e.g., respond to training-related emails and questions).

CVA Leads: “The problem is that the administration ‘soaked up what we do.’ Tools are a nightmare. Because people know us they ask us questions individually, instead of sending questions to an administration mailbox where our administration support person monitors. Overall, the administration hours increased because ‘increased demand’ increased number of participants and number of sessions.”

Figure 4 illustrates the results², which we will revisit later when discussing the simulation model.

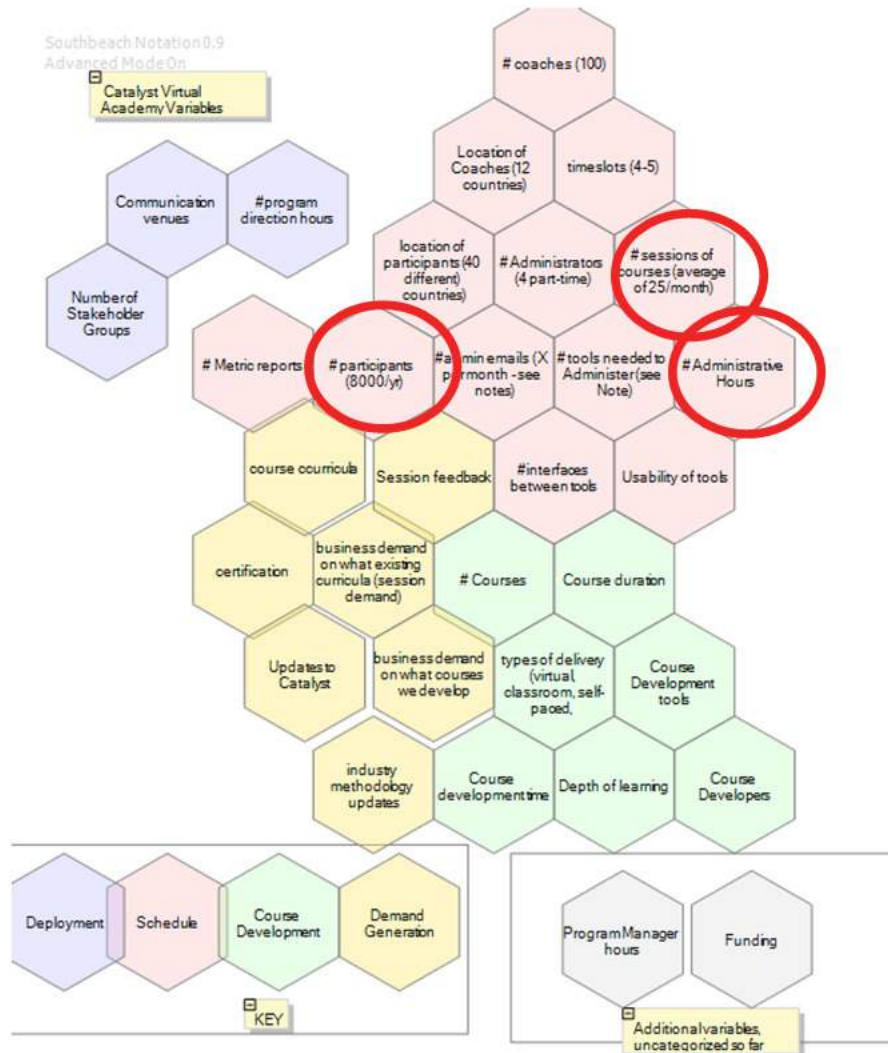

Figure 4. Variables Characterizing the Program

CVA Leads Insights: “We were amazed with how quickly this hexagon approach summarized our business variables in a new light.”

4.2. Reference Modes, Momentum Strategies and Success Factors

Figure 5 illustrates the reference modes for Participants and Sessions. Both modes are based on historical data prior to March 31, 2011 (the end of fiscal year 2010). We used historical data to capture these reference modes and tried to explain its shape based on events. For example one CVA Lead joined CVA shortly around 2008 and increased the number of communication channels that advertised the CVA. The rate of increase of monthly participation and sessions became steeper after that date as is illustrated in Figure 5. Another factor in this steep increase was that prior to 2008 there was only one CVA Lead.

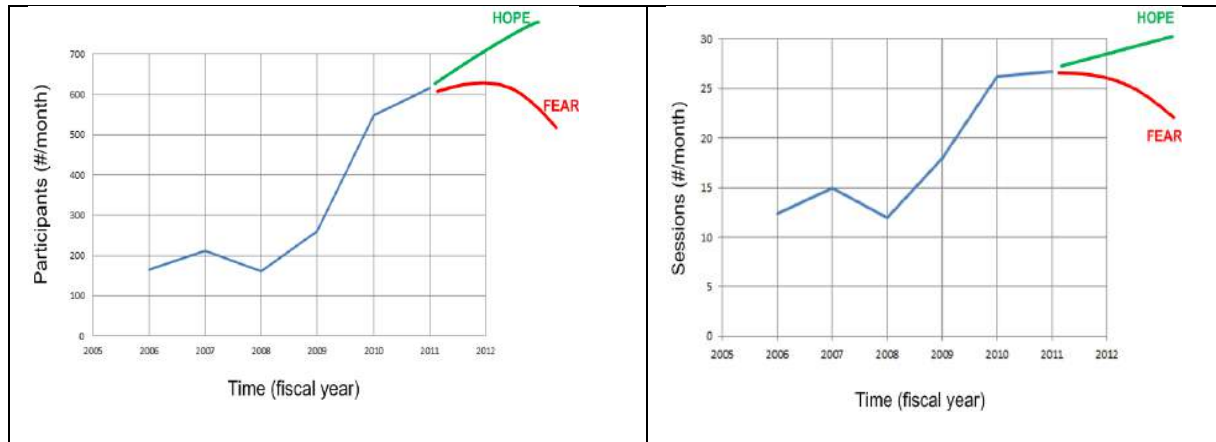

Figure 5. Monthly Participants and Monthly Session Reference Modes

Figure 6 illustrates Administrative Time (per month), which is perhaps the most critical reference mode. This mode pointed to the pain the CVA Leads felt because of time spent doing more and more administrative work to manage increased CVA participation. They hoped they could find a way to minimize the overall administration time required (e.g., with new tools) and to minimize the fraction of this required time involving them. They would rather manage other aspects of the program, e.g., creating new courses.

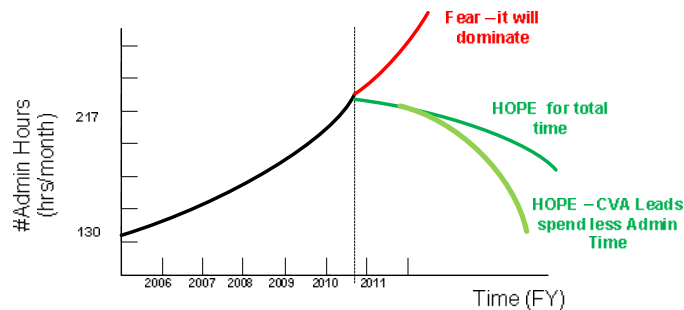

Figure 6. Monthly Administrative Reference Mode

CVA Leads Insights: “For the reference mode diagram where there is really data (#participants, #sessions), we can talk tons, but we haven’t thought much about the number of administrative hours. Where we have been interested in the outcome, we have done measurements. Where we don’t have measures, we have more of a problem to articulate. Because we built a relationship of something we did not measure in terms of things we have measured, we can now focus on it.”

What are those momentum strategies (policies) - what is done now?

CVA Leads (2011): “We thought there were several ways to diminish our administrative time: improve the process of how we run the CVA, improve the tools we use to run the CVA, and explore new ways of training, e.g., self-paced trainings.”

How will we know if the use of System Dynamics is successful?

CVA Leads (2011): “If its use helps solve or provide insight into solutions of the administrative problem. And as a consequence we spend less time on administration and more on management (e.g., course content and instructors).”

5. Create a Dynamic Hypothesis

Figure 7 illustrates the process we used to create the dynamic hypothesis, which provides a possible and hopefully plausible explanation for the reference modes. We first created a rough dynamic hypothesis using the key variables by trying to understand the factors in historical events that led to noticeable changes in these variables. For example, as mentioned earlier one CVA Lead joined CVA shortly around 2008 and increased the number of communication channels that advertised the CVA. The CVA Leads felt that this advertising was one factor responsible for the subsequent steep increase in participation as well as having a second CVA Lead. The number of active CVA Leads affects overall participation, which was confirmed in 2012 after this model was completed when the program had one CVA Lead for a while. Eliciting a rough dynamic hypothesis helped us define the system boundary (scope) by considering the factors (e.g., advertising, new courses) and corresponding feedback loops we felt affected the reference variables.

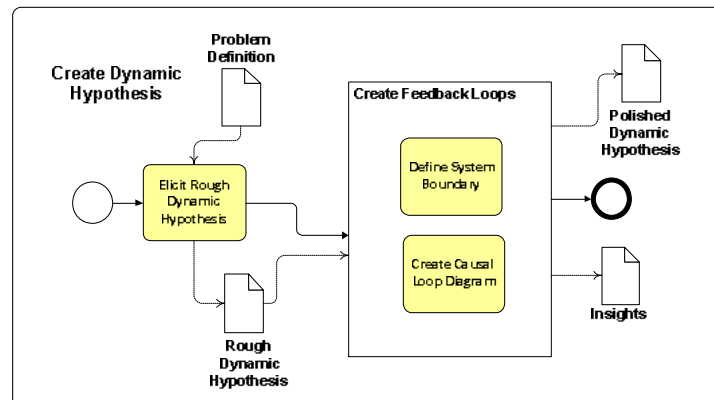

Figure 7. Creating a Dynamic Hypothesis

Figure 8 illustrates the final polished dynamic hypothesis, which went through many iterations starting with the rough dynamic hypothesis. It was recently untangled for a clearer presentation in this paper. It is still a complex diagram, yet has some simple messages to keep in mind before we discuss it in more detail:

- Good advertising and positive networking can increase participation (see loops R1 and R2)
- Spending too much time doing administrative work can prevent the CVA leads from doing things that can increase participation
- Success in increasing participation can lead to more administrative time, thus limiting success.

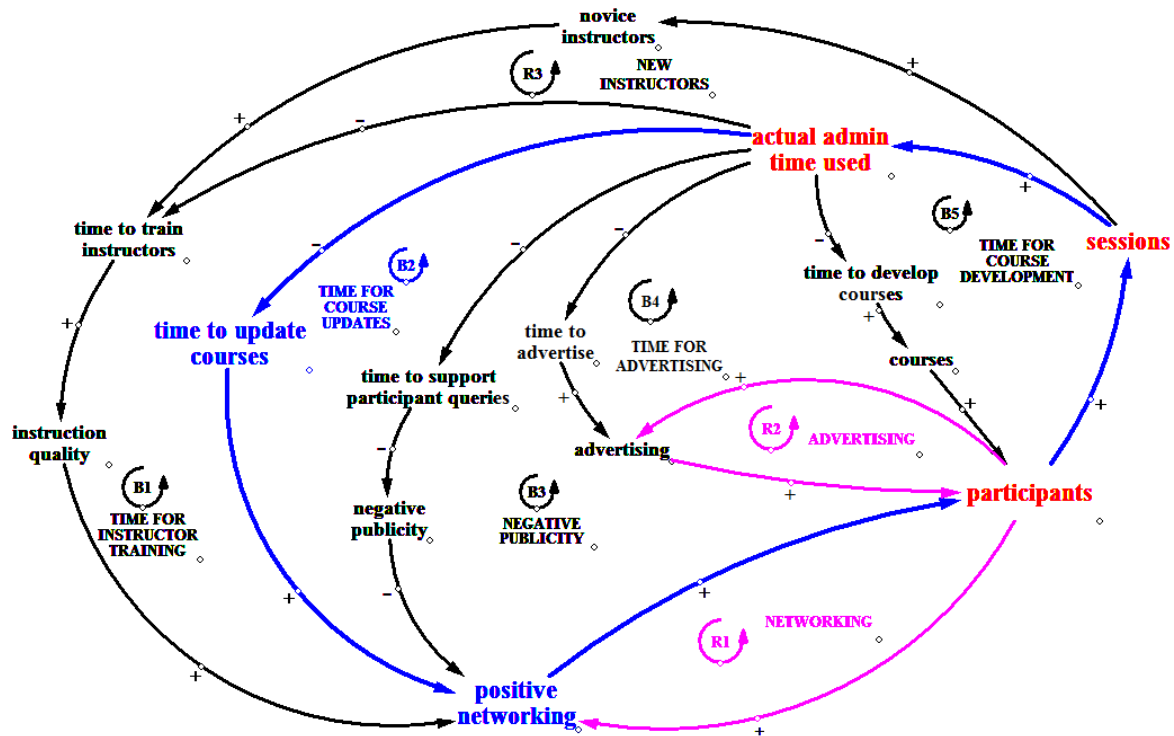

Figure 8. Polished Dynamic Hypothesis

The more “administrative time” used the less time was available for instructor training, course updates, advertising and course development. These items and publicity and networking effects defined the scope of this causal model and set the stage for defining the simulation model, which fleshed out the scope. All the balancing loops (B1 through B5) go through all three key variables, which we highlighted using B2 as an example (thick blue line). These are all balancing loops because being successful brings in more participants thus increasing the number of sessions to handle them. The larger number of sessions increases the administrative time and thus decreases the time available to work on those activities that increase participation leading to declining participation. Networking, advertising and new instructor training are positive loops, which all include participants. These loops could either increase or decrease participation. The CVA Leads like the word “networking” versus “word of mouth” since the former seemed more appropriate and formal to them for this context.

6. Develop the Simulation Model

Figure 9 illustrates the process of constructing the simulation model.

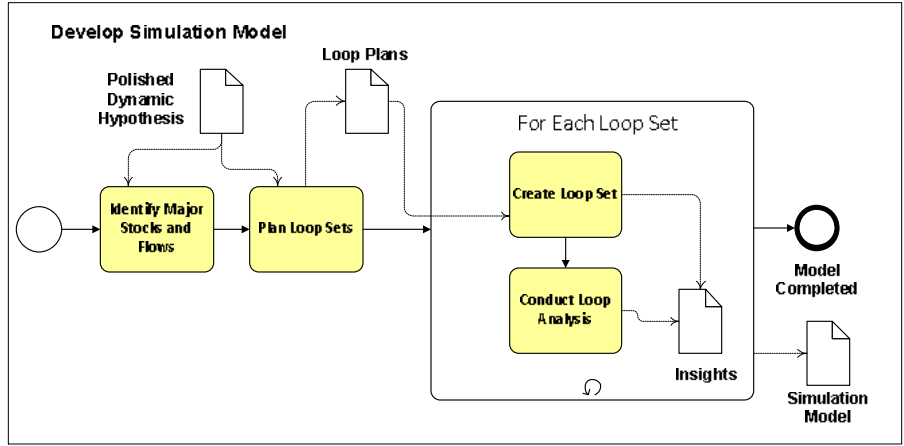

Figure 9. Develop Simulation Model

Since the simulation model was getting complex, we (conceptually) divided the model into modules as illustrated in Figure 10. We also increased the scope of the model to include the time the CVA Leads spend conducting CVA trainings.

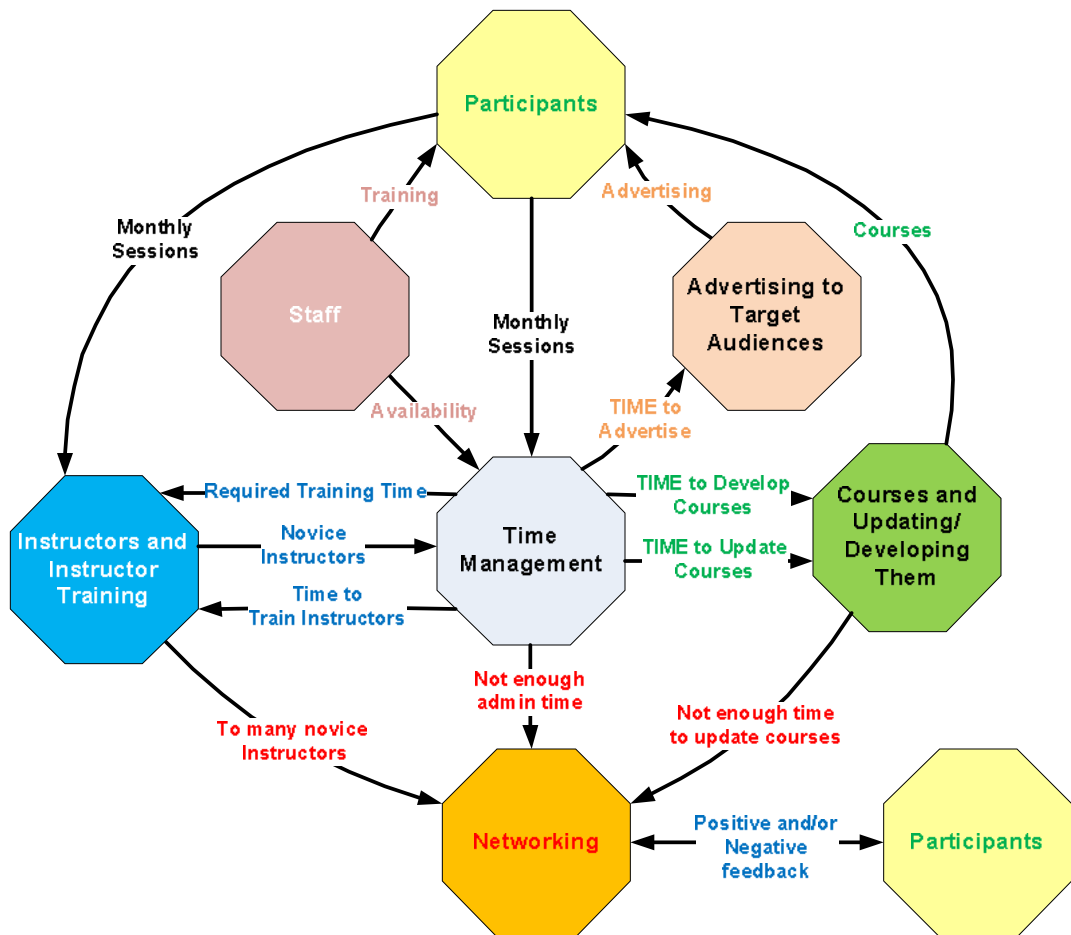

Figure 10. Simulation Model Modules

The full, detailed model is included in the supplementary material. However, Figure 11 illustrates a sample of the model by listing some of the model modules with some variables omitted for clarity.

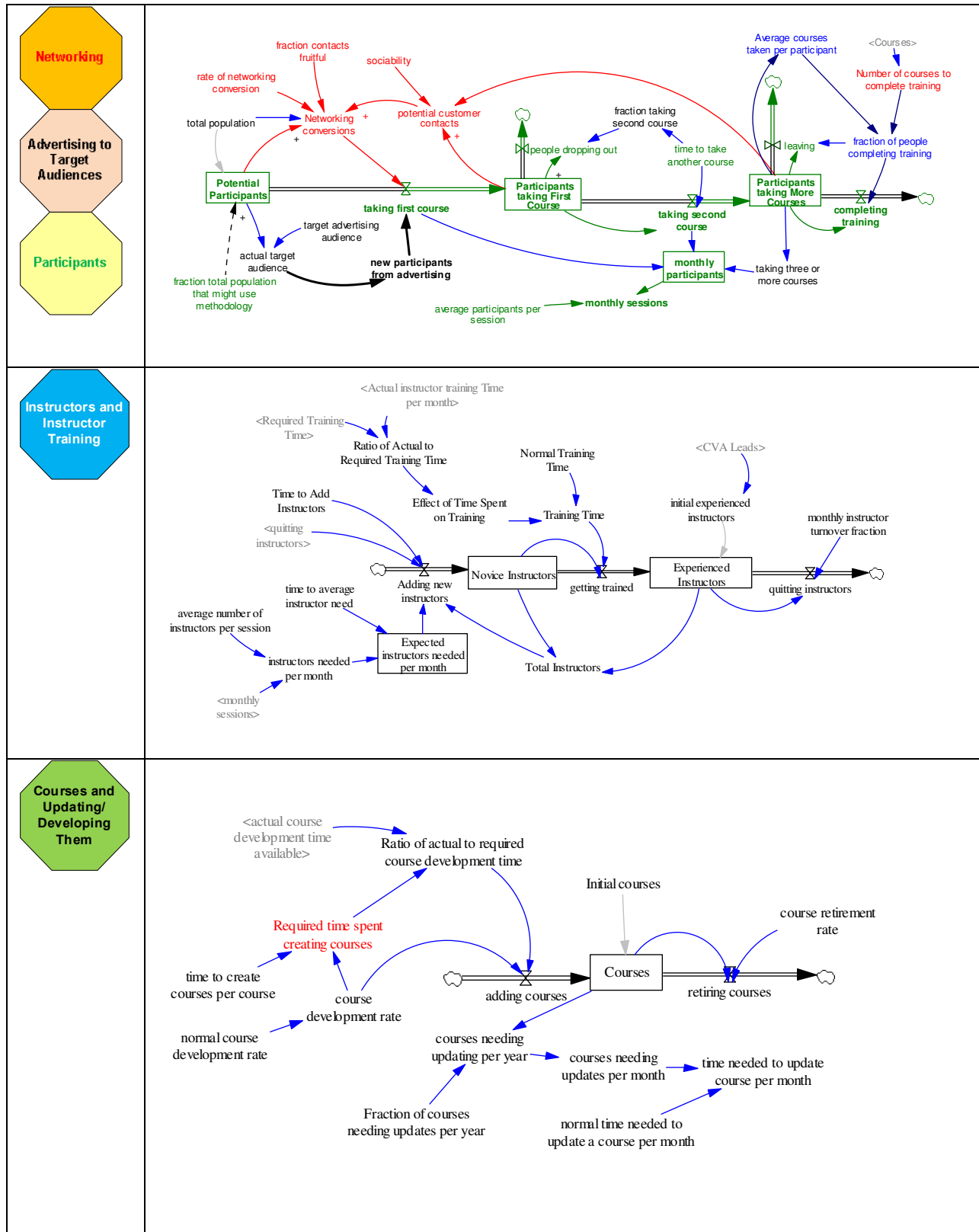

Figure 11. Model Segments

The simulation model addressed the problem space, covering many initially elicited variables and adding more. The effects of some initially elicited variables were aggregated in model variables (e.g., the drain on administrative time caused by addressing emails). Figure 12 indicates which initial variables found their way into the model.

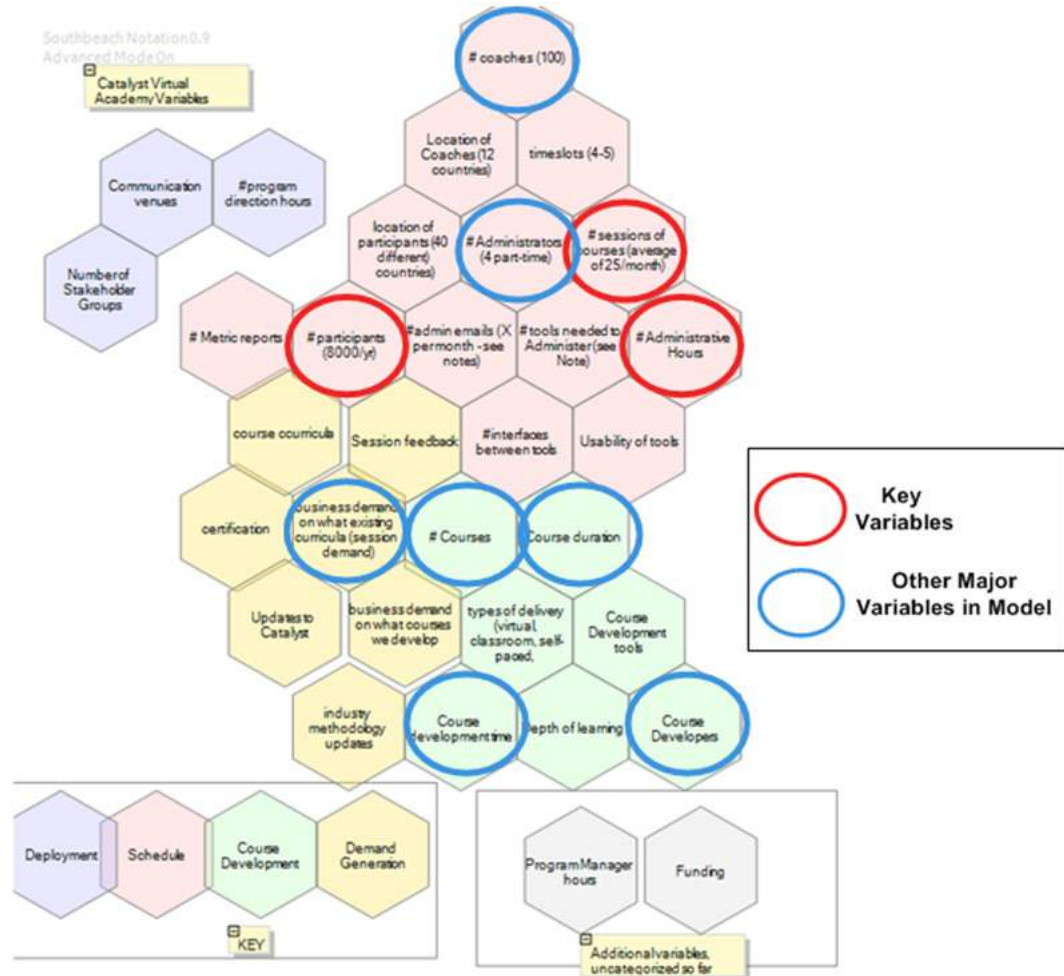

Figure 12. Initially Elicited Variables in the Model

The model introduced new variables (e.g., yearly instructor turnover fraction, course development rate, and number of unique participants), which were discovered later.

We created baseline run parameters to match the historical data to the model. The list of parameters and their baseline values are included in the supplementary material along with the simulation model. Figure 13 compares the reference modes with the results of a baseline simulation run. The goal was to be in the right ballpark.

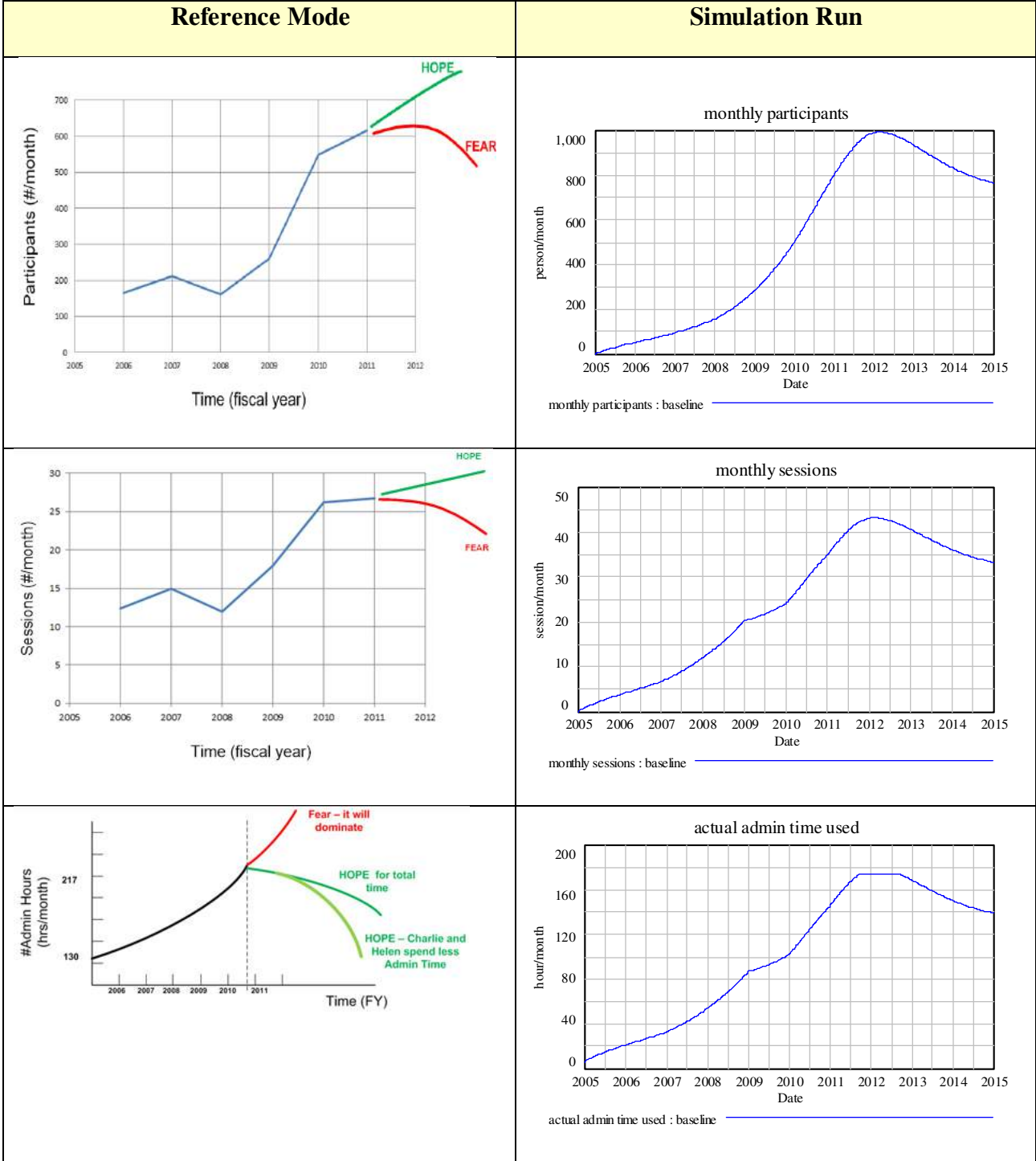

Figure 13. Baseline Simulation Runs of Key Variables

In the simulation run for monthly participants, the CVA Lead’s fear was realized. What, if anything, can be done to prevent it? Note that in late FY 2011 the administrative time begins to flatten out. This means there are so many participants that there is not enough administrative time to support them. In late FY 2012, administrative time drops because the number of participants drops.

We also looked at other variables and compared the results of simulation runs with historical values as Figure 14 illustrates. Based on the simulation results we decided the model was good enough to provide insight.

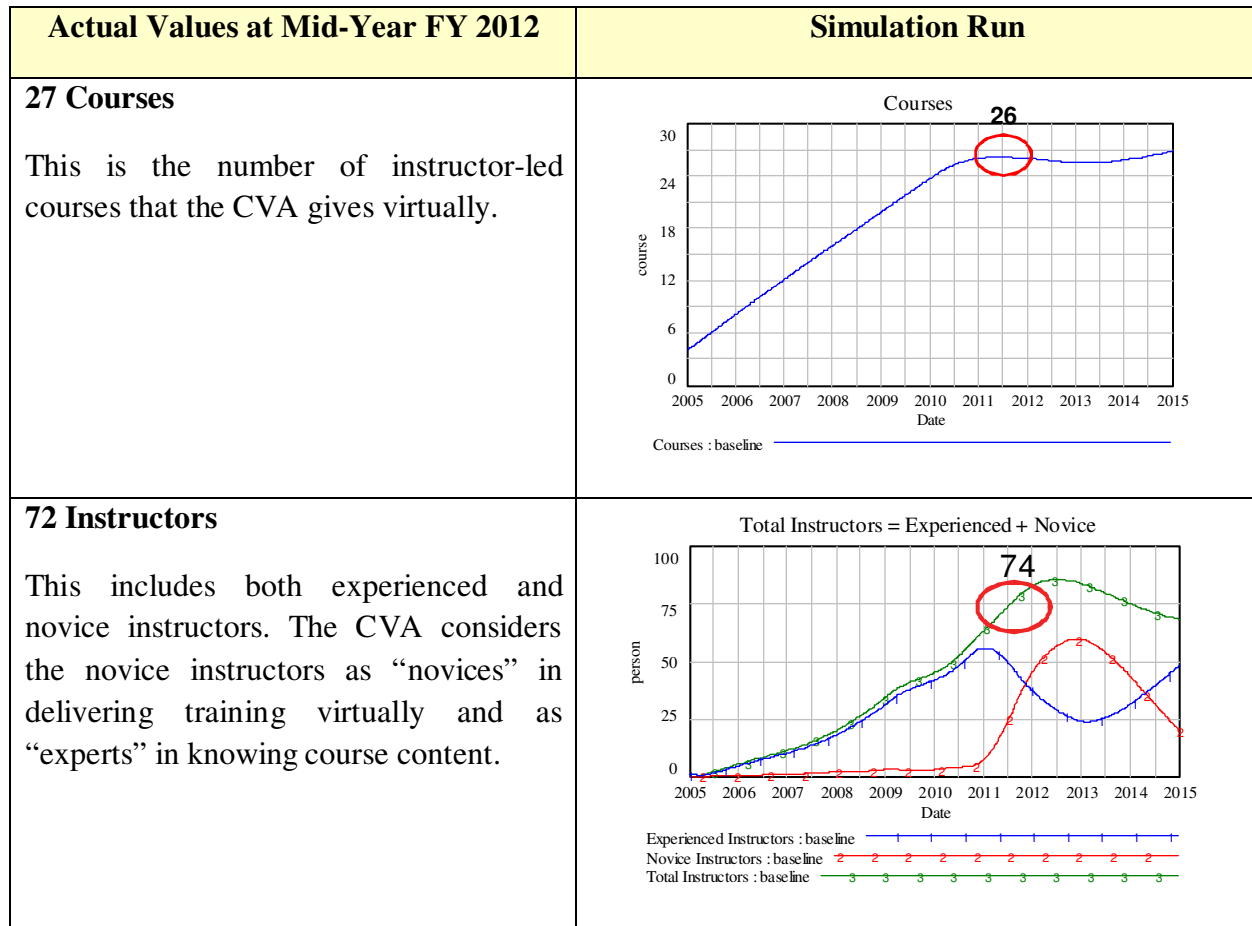

Figure 14. Other Variables are in the Numerical Ballpark

7. Design Strategies (Policies)

This section includes a sample of the runs we ran to test various strategies. The runs explore changes beginning in Fiscal Year 2011 from the baseline values.

- What happens if we become more efficient at handling administrative activities?
- What is the effect of changing the number of CVA administrative support staff?
- What happens if the CVA shifts priorities to training instructors and developing courses?
- What happens if the CVA makes training instructors the top priority?

7.1. Administrative Time Efficiency Improvements

“Administrative time per session” is the biggest contributor to administrative time. Tools or better processes could lesson this time, or it could be done by another group and be near zero.

This may affect cost of service (\$ per participant or per course), however a financial module is not in the current model.

Figure 15 illustrates a series of runs where we varied “Administrative time per session” after 2011 from “0 hours/person” (some other group does it) to “4 hours/session” (the baseline).

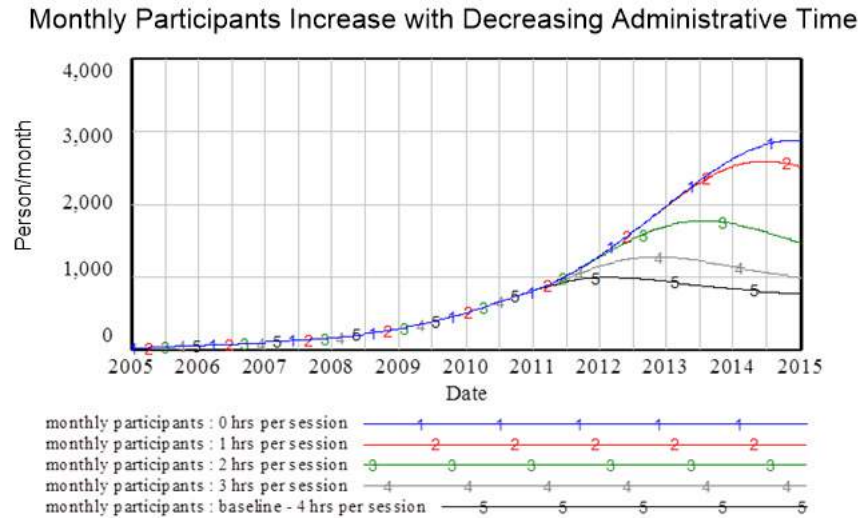

Figure 15. Effect of Variations of Administrative time per Session

With more time to spend on CVA management activities (e.g., developing courses, training instructors) participation will increase. However, as we will shortly show, this will tax resources. To understand the next two runs, we need to define two variables:

- **Available Hours.** The hours left for management activities (e.g., training instructors, creating and updating courses, and advertising) after the CVA Leads have spent time on Administrative activities.
- **Required Hours.** The hours needed to support creating and updating training, training instructors, and advertising to target audiences.

Figure 16 illustrates how these variables change when the administrative time per session is zero, e.g., it done entirely by another group. Even with administrative time/session done completely by another group, participation will swamp resources at times (last quarter 2012)

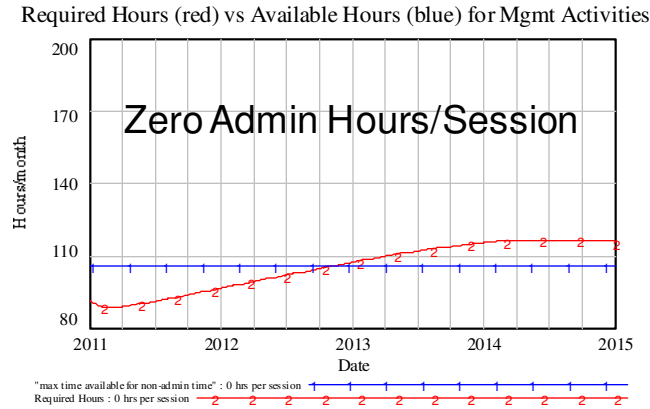

Figure 16. Required vs. Available Hours When Administrative Hours/Session = 0

Figure 17 illustrates the effect of having just two administrative hours per session. If we have better tools or processes to reduce administrative hours per session to two or three hours resources will be swamped sooner (second quarter 2011) than when no “administration time per session” is required.

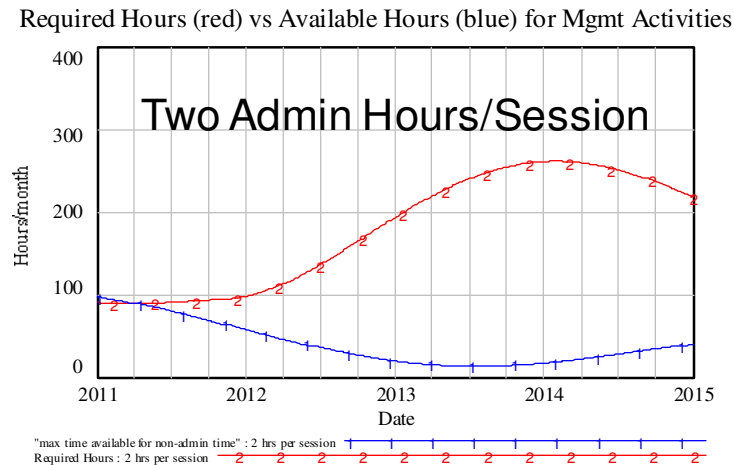

Figure 17. Required vs. Available Hours When Administrative Hours/Session = 2

The run where there are zero administrative hours per session (see Figure 15) raise a question. Why does the number of participants level off in the second half of 2014? What limits growth? We modeled “potential participants” as a stock that just drains and is never replenished. This reduction in potential participants eventually leads to a decrease in the number of monthly participants. In reality people will join and leave the company.

7.2. Changing Administration Support Staff

Figure 18 shows how increasing Administrative Support staff in 2011 increases monthly participation, although participation eventually drops off. If Administrative Support is lost in 2011, monthly participation begins to drop as expected.

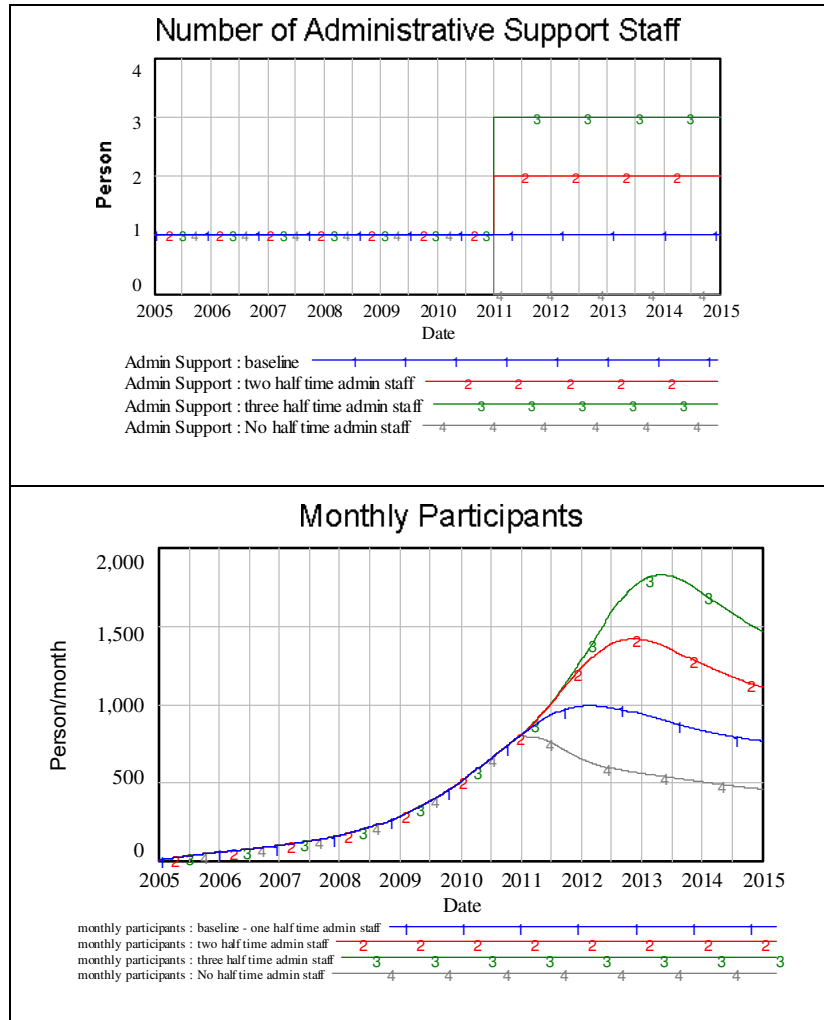

Figure 18. Changing Administration Staff Support

As Figure 19 illustrates, monthly participation increases initially because more time is available to the CVA Leads to do the management activities (e.g., advertising and training) that increase participation. However, with increasing success the CVA Leads will have less time for these activities and participation will decrease.

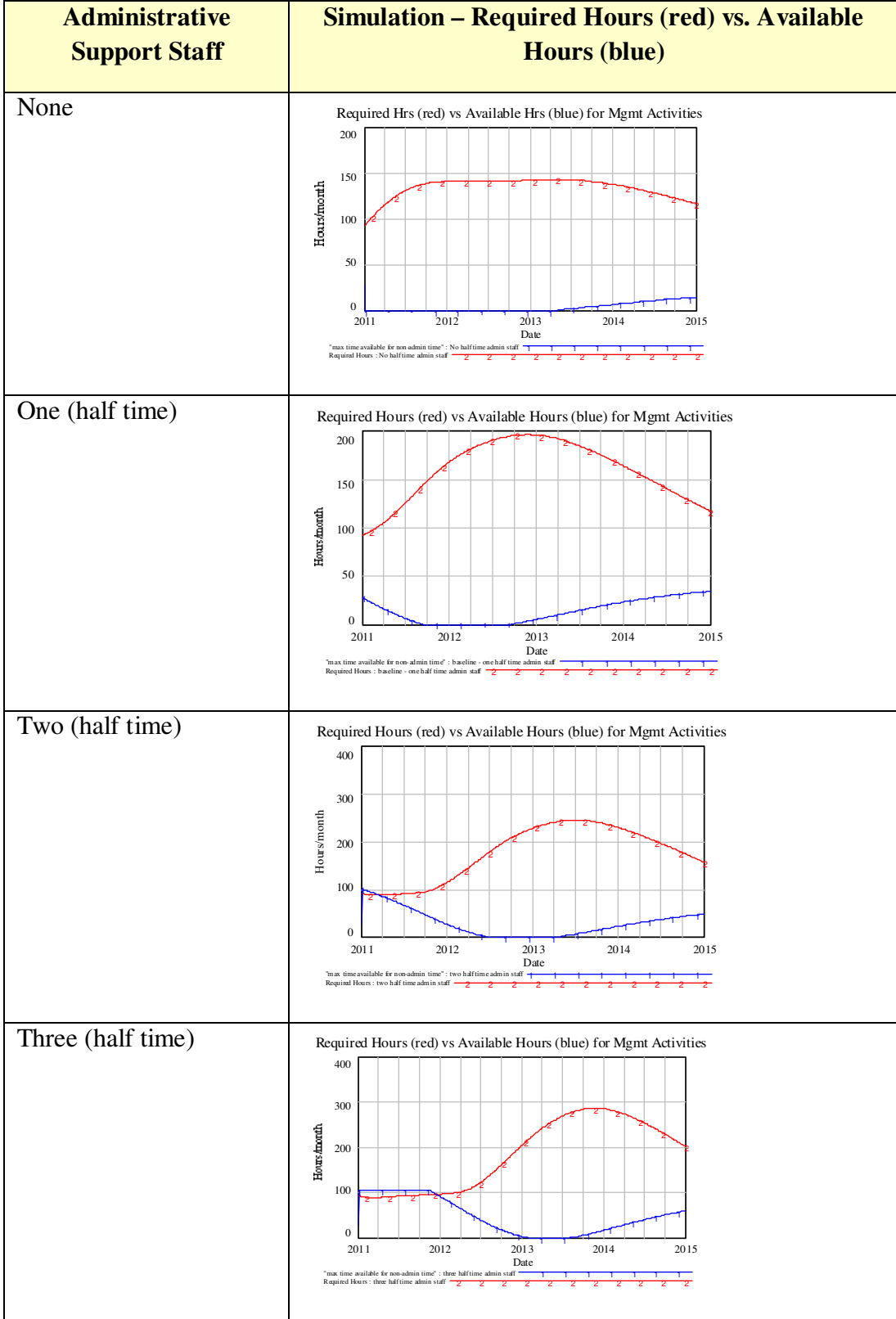

Figure 19. Simulation Runs each with a Different Number of Administrative Support Staff

7.3. Shifting Priorities to Training Novices and Developing Courses

Assume that beginning in 2011 priority is given equally to just training novices and developing courses, any time left is allocated to updating courses, and no time is devoted to advertising. Figure 20 illustrates that this strategy results in fewer novices and more developed courses as expected.

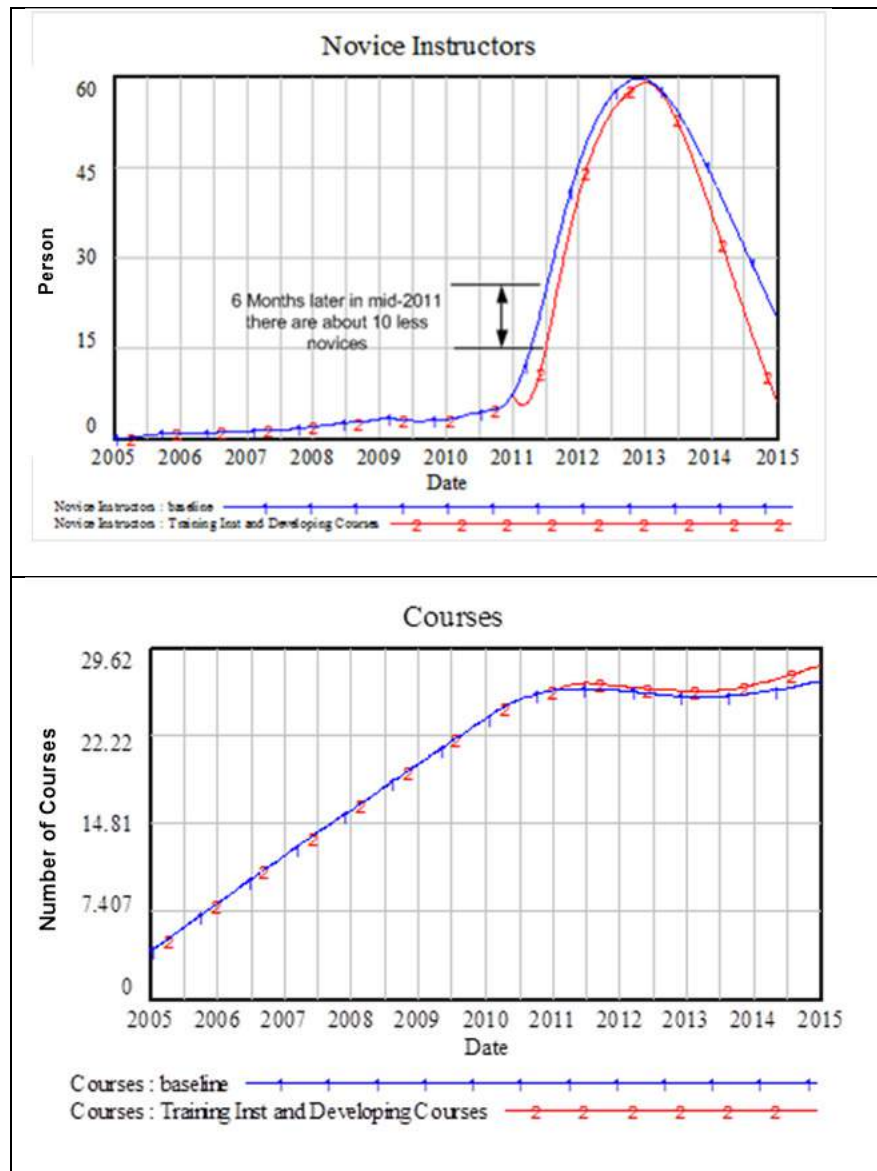

Figure 20. Effect of Focus on Training Novices and Developing Courses

Figure 21 illustrates that this strategy brings in more monthly participants for two reasons:

- Having more courses increases participation
- Having fewer novices' results in less bad press leading to more participation.

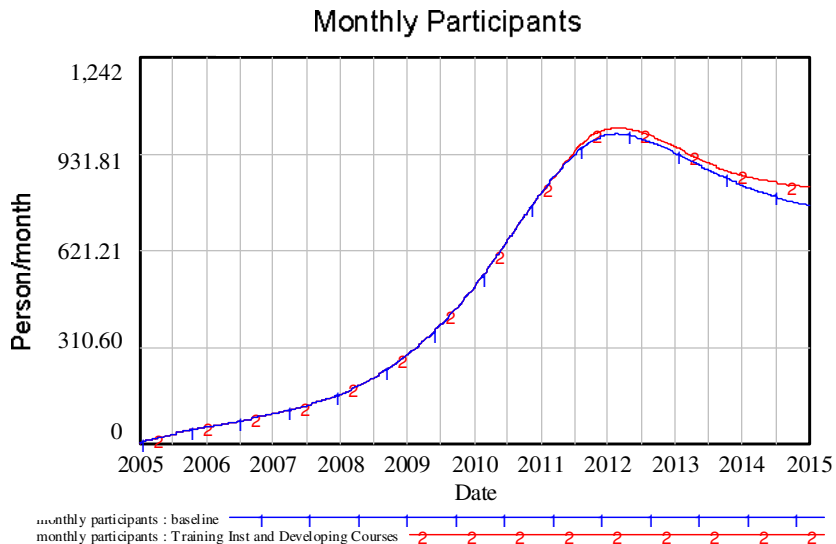

Figure 21. Effect of Training Novices and Developing Courses on Monthly Participates

7.4. Making Training Novices Priority One

CVA Leads: “We need to spend more time with trainers. For the ... curriculum, we took administration away and then we had a problem with a drop off in participation. Insight – need to train instructors. We should help the trainers get kicked off correctly.”

Assume that beginning in 2011 priority is given to just training novices. Any time left is allocated to developing and updating courses and no time is devoted to advertising. Figure 22 illustrates that after a time delay this strategy brings in more participants. One insight to the CVA Leads was that some new strategies may take a while to show an impact.

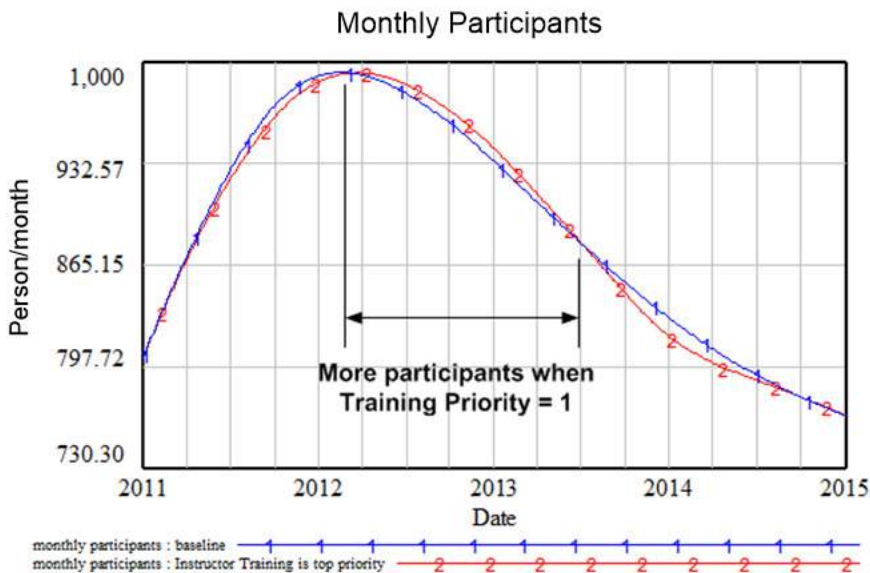

Figure 22. Effect on Monthly Participation when Training Novices is the Top Priority

8. Growth and Underinvestment Archetype as Applied to the CVA

After we completed the simulation model and ran many simulations, we realized that the Growth and Underinvestment Archetype addressed the situation. Figure 23 illustrates the generic archetype and its application to the CVA. Identifying the archetype helped us communicate the results.

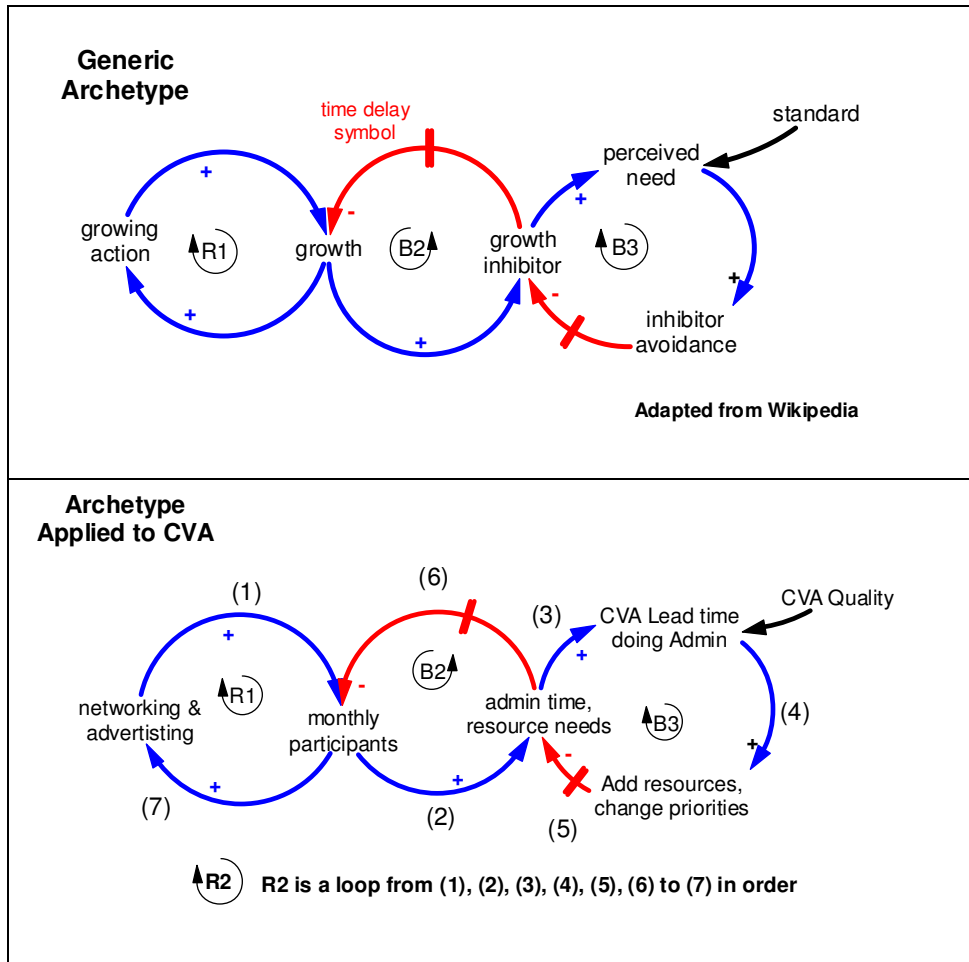

Figure 23. Growth and Underinvestment Archetype

Like a thermostat, the loop B3 from (3), (4) to (5) helps balance administrative needs if resources are available. R2 is a big loop that goes from (1), (2), (3), (4), (5), (6) to (7) in order. If we keep adding resources (or in some cases change priorities) within loop R2 when monthly participation increases we can handle this increase. If success in networking and advertising bring in more monthly participants and additional resources are not available then from B2 and B3 monthly participation will decline. The bottom line for the CVA is that adding appropriate resources when needed helps maintain and nurture success.

CVA Leads: “Identifying the archetype demonstrated to us that our business problem was not unique, but had characteristics that were experienced by many others. We were able to benefit from insights and aspects of the archetype that we would not have considered otherwise.”

9. Conclusions and Retrospective

In summary, the CVA is successful, but success is slowing down. Actual data shows that CVA Leads are hitting a brick wall with more of their time devoted to administration. Adding more curricula will make it worse. The model indicates through the addition of resources or changing priorities, we can move the wall to the future, but not eliminate it (at least within the current model). Adding appropriate resources, when needed, helps maintain and nurture success. Otherwise, CVA scope needs to be limited.

The next few sections discuss how our thinking changed about the problem, responses to the initial questions we posed on the system dynamics approach, and promising strategies.

9.1. Changes in Our Thinking

Working on the model brought us a number of changes in our thinking about the problem:

- In the reference mode for the number administrative hours, the future hope is that it drops off rapidly. That is what we see in the model, but it may not be what we want. It drops off in the model because participation dropped off. Participation drops off because of a previous cycle of not being able to handle growing participation. So maybe the reference mode really should be “CVA lead hours” spent doing administrative work rather than total administration hours.
- Doing things that make training better can have unintended consequences. For example, improving the process or tools may bring in more people but administrative time will get worse eventually limiting participation.
- We need to advertise to our trainers, because they are highly influential stakeholders. Not all trainers are aware of all the courses. Participants ask trainers “What do I do next?”
- We initially thought the Growth and Underinvestment Archetype seemed unimportant. Then, we examined it more detail (see Section 8) to confirm that it actually applied. We used “Administrative time and resource needs” as a growth inhibitor. We realized later that even if we make a radical change there might be other “growth inhibitors” lurking in the background (e.g., constrained budget). When we were done, we all better understood the archetype – now that it reflected concrete model results.
- This System Dynamics analysis points to things to consider measuring.
- Finally, we all went from initial thoughts of incremental improvement to a change in program focus and redesign.

9.2. Initial Questions on System Dynamics Approach

Initially we asked, “How can the use of System Dynamics bring value within a large company?” and “Does the value come from just the results of the modeling effort or is the journey to those results also important? Here is some client comments on the modeling effort related to these questions:

“This is bringing out the dimensionality of issues that may be hidden. Humans don't think this way -- all of this is what I know but I don't know it in relationship to other things I know.”

“It is crystallizing my thoughts.”

“We can improve advertising. We can better articulate tool requirements because we now understand our process and the problem better -- because of what we have done.”

“We can now dialogue because of the level of complexity of the work we have done during this project. Every time we meet brings my thinking to another level.”

“We can use the model to support our strategic direction.”

Do the results leave a lasting impact? One CVA Lead said that their mindset about how to think about CVA changed and he views new CVA activities in this light.

9.3. Promising Strategies

CVA Leads: One of the obvious findings of our work with Systems Dynamics was that our business system was severely constrained, by administrative resources, instructor availability, and course development capabilities. We went from initial thoughts of incremental improvement to a change in program focus and redesign. Moving forward from fiscal year 2012 we have begun to implement radical changes to the program. For example:

- We have adopted a strategy of offering more self-paced training, particularly some of our older, less well-attended courses. We can then devote more resources to developing new and fresh leader-led ones.
- We are investigating alternative mechanisms for administrative support, e.g., using a shared service model. This is being greatly facilitated by changes in the focus of our company's Human Resources department towards a more centralized learning administration environment.
- We are experiencing a shift in the nature of our demand from a launch model (push), where soliciting new people and new course material is important, to a maintenance model (pull), which maintains high enthusiasm, provides quality courses – relevant to the business, and ensures quality instructors. While this shift is not directly the result of our analysis of the results of our Systems Dynamics models, we were able to recognize the trend and adjust our levels of communication and administration accordingly.
- We also think that System Dynamics models should be as tools to at least help plan our CVA approach each year. The model gives verifiable insights.

Bibliography

Hines, James M. "Launching System Dynamics." *Proceedings of the 1994 International System Dynamics Conference*. Stirling, Scotland, 1994.

Kreutzer, David. "Hexagons: from Ideas to Variables." *The System Thinker, Vol 8, No 9*, 1997.

Lyneis, James M., and James H. Hines. "Implementation Issues." In *Encyclopedia of Life Support Systems, Section 1-3*. Mississauga: Eolss Publishers Co. Ltd.

Acknowledgements

Pascal Gambardella (the modeler) would like to thank Jim Lyneis for providing valuable feedback during the Real World System Dynamics course he taught at WPI. I am also grateful to his requirement to keep detailed notes throughout the modeling effort. These notes made writing this paper much easier. He would also like to thank Rod McDonald for suggesting modeling improvements during a modeling workshop at a System Dynamics Society Conference.

The authors would like to thank the reviewers for their feedback.

DISCLAIMER

The information, views and opinions expressed in this paper constitute solely the authors' views and opinions and do not represent in any way CSC's official corporate views and opinions. The authors have made every attempt to ensure that the information contained in this paper has been obtained from reliable sources. CSC is not responsible for any errors or omissions or for the results obtained from the use of this information. All information in this paper is provided "as is," with no guarantee by CSC of completeness, accuracy, timeliness or the results obtained from the use of this information, and without warranty of any kind, express or implied, including but not limited to warranties of performance, merchantability and fitness for a particular purpose. In no event will CSC, its related partnerships or corporations, or the partners, agents or employees thereof be liable to you or anyone else for any decision made or action taken in reliance on the information in this paper or for any consequential, special or similar damages, even if advised of the possibility of such damages.

Endnotes

¹ We expressed the process diagrams in the Object Management Group's (OMG) Business Process and Modeling Notation (BPMN). A plus sign in an activity signifies that the activity has lower level tasks.

² The application Southbeach from www.southbeachinc.com was used to elicit information and draw this diagram.